

REVISION RECORD

REV.	DESCRIPTION	ECN No.	APPROVED	DATE

技术参数/Technical specification

插芯 Inserts	
• 接插件针数 Number of contacts	7+PE
• 额定电流 Rated current	10A
• 额定电压 Rated voltage	400V
• 额定脉冲电压 Rated impulse voltage	6KV
• 污染程度 Pollution degree	3
• 绝缘电阻 Insulation resistance	$\geq 10^{10} \Omega$
• 材料 Material	聚碳酸酯 Polycarbonate
• 颜色 Colour	RAL7032 灰白 Light grey
• 依据UL/CSA额定电压 Rated voltage acc.to UL/CSA	600V
• 工作温度范围 Limiting temperatures	-40℃~+125℃
• 依据UL94阻燃等级 Flammability acc.to UL94	V0
• 可拔插次数 Mechanical working life (mating cycles)	≥ 500
插针 Contacts	
• 材料 Material	铜合金 Copper alloy
• 表面处理 Surface	镀银 Silver plated
	镀金 Gold plated
• 接触电阻 Contact resistance	$\leq 3m\Omega$
• 接线方式 Terminal	冷压连接 Crimp Terminal
• 导线规格 Wire gauge mm ² /AWG	0.14~2.5mm ² /AWG 26~14
• 拧紧力矩 Tightening torque	M3/0.5 N.m
• 剥线长度 Stripping length	6~8mm

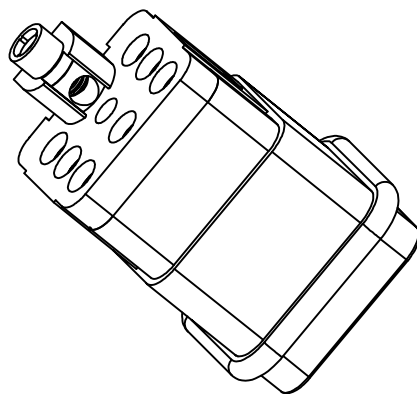
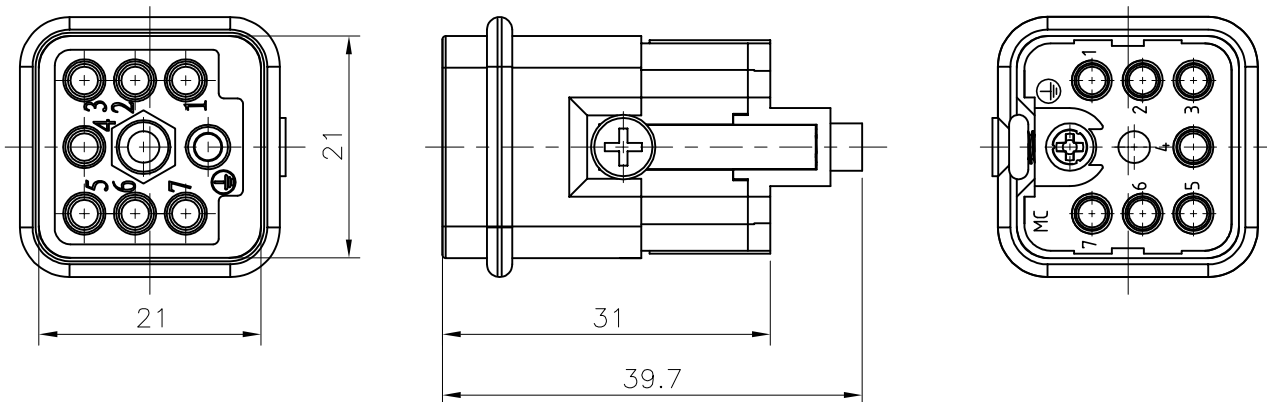

备注：压接触针需单独订购
Note: Crimp contact pins should order separately

未注公差按DIN ISO 2768-c
Undeclared tolerance according to DIN ISO 2768-c

DES.	CHEN HK	DATE	2023. 07. 06	单位 / UNITS	mm	尺寸 / SIZE	A4	比例 / SCALE	1:1	第三视角 / THIRD ANGLE PROJECTION 	版本 / REV	A
CHK.	CEN LF	DATE	2023. 07. 06	慈溪市科发电子有限公司 CIXI KEFA ELECTRONICS CO., LTD		名称 / TITLE		KQ-007-MC				
APP.	HUANG DK	DATE	2023. 07. 06									